

S. 150 Nr. 1

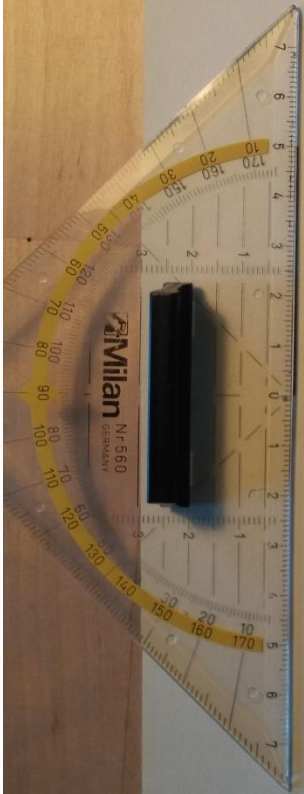

S. 150 Nr. 1

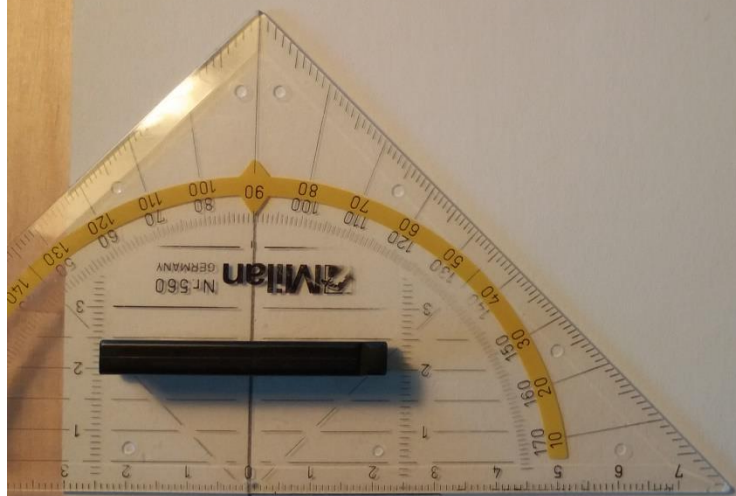

S. 150 Nr. 1

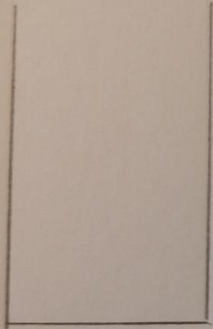

S. 150 Nr. 1



S. 150 Nr. 1

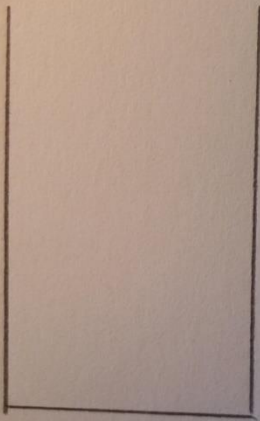

S. 150 Nr. 1

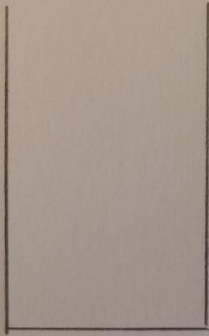

S. 150 Nr. 1

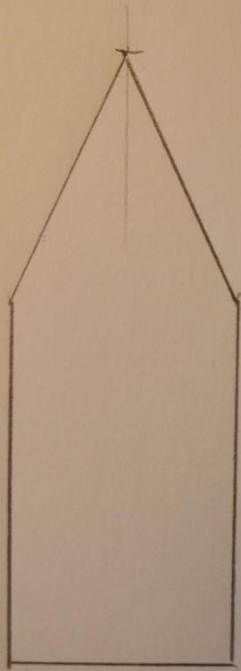

S. 150 Nr. 1

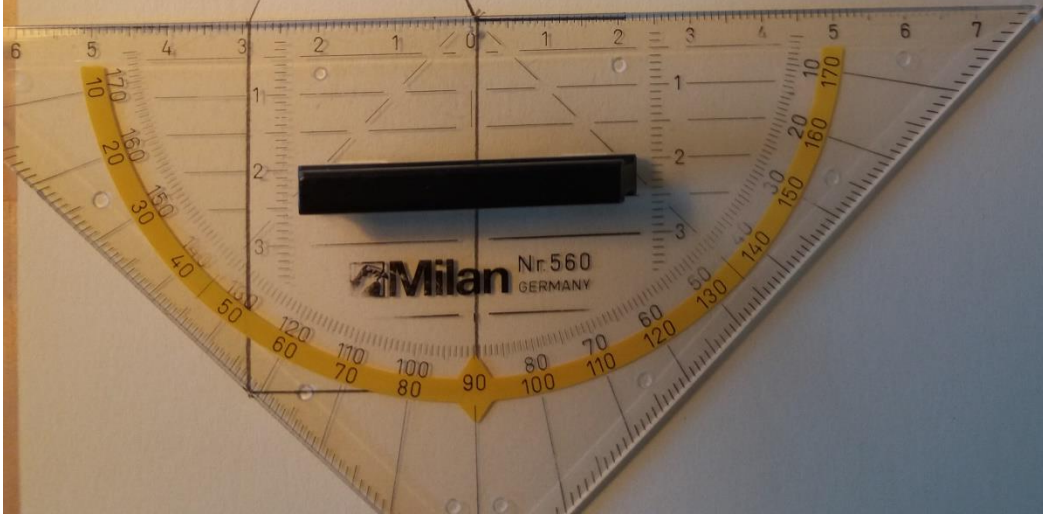
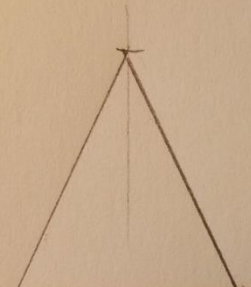



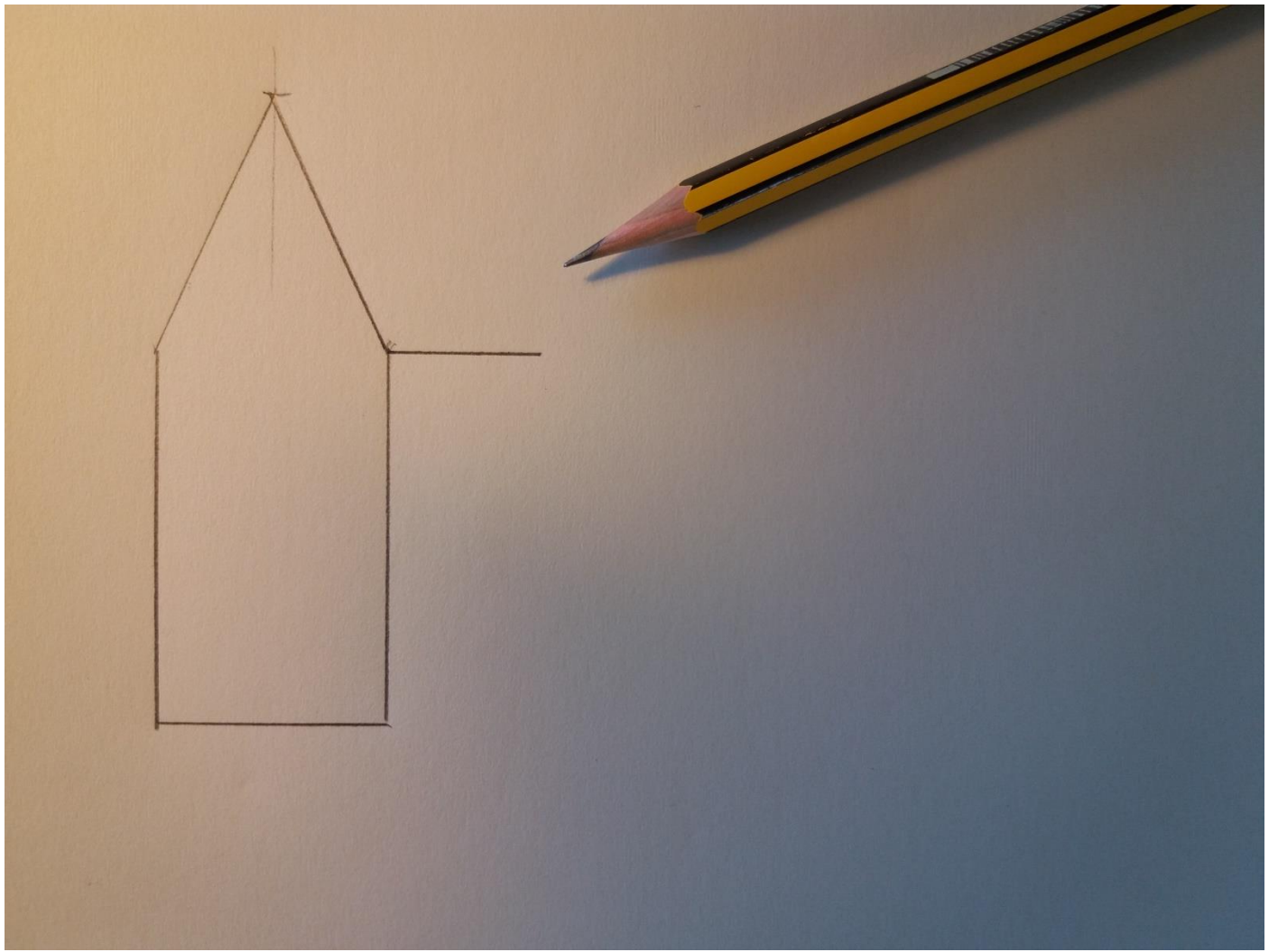

S. 150 Nr. 1

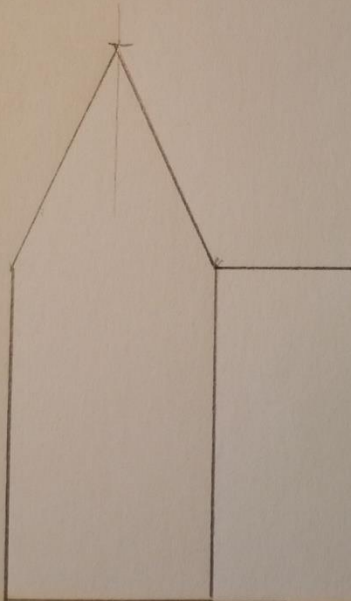

S. 150 Nr. 1

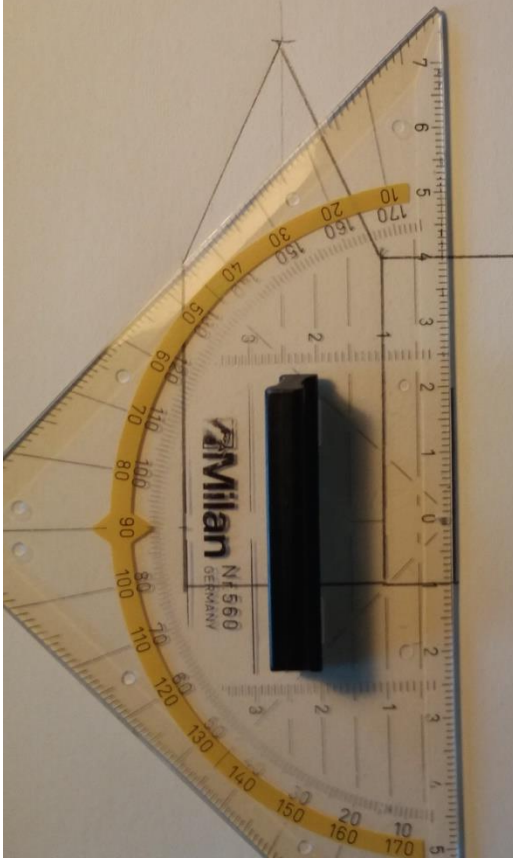

S. 150 Nr. 1

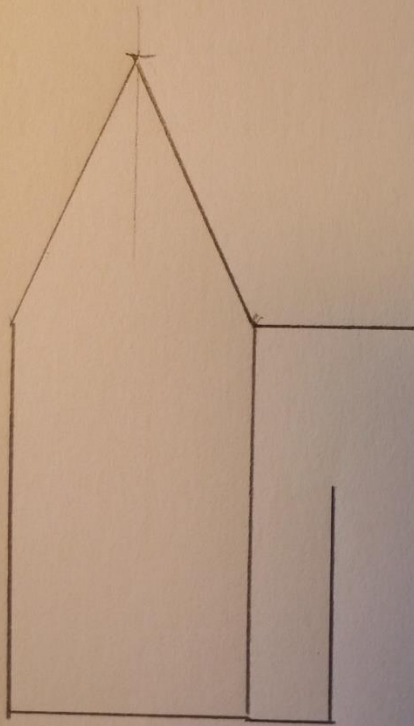

S. 150 Nr. 1

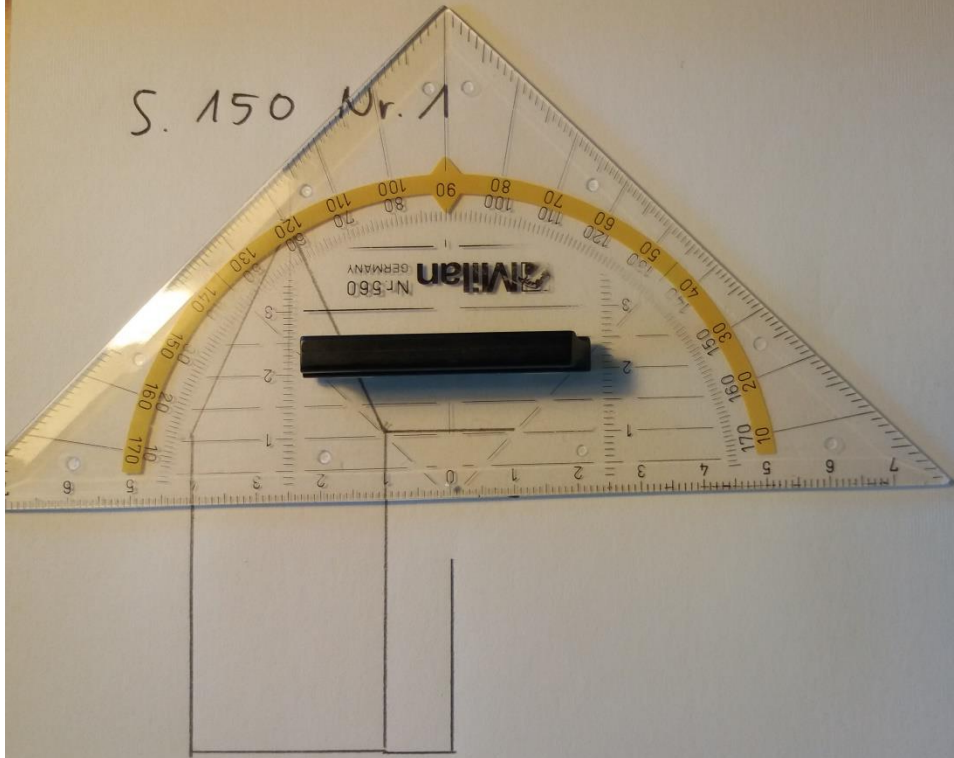

S. 150 Nr. 1

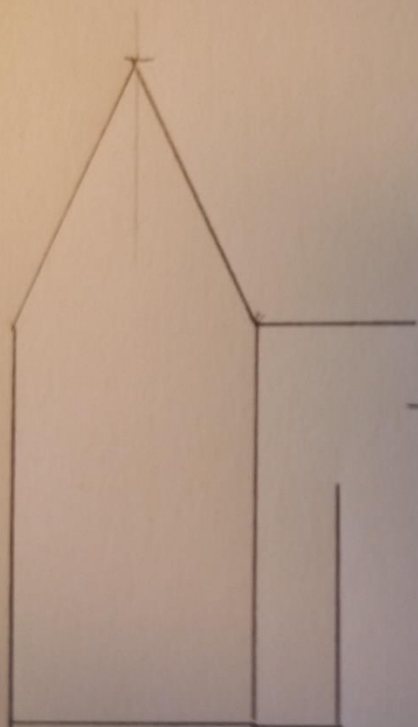

S. 150 Nr. 1

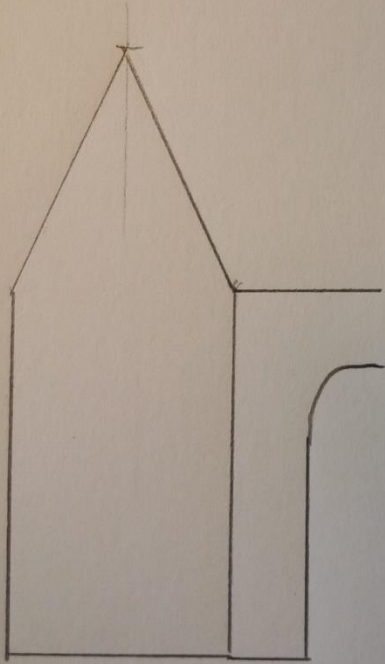

S. 150 Nr. 1

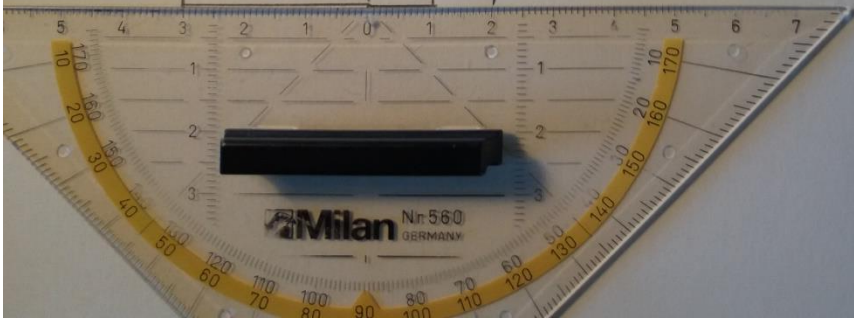
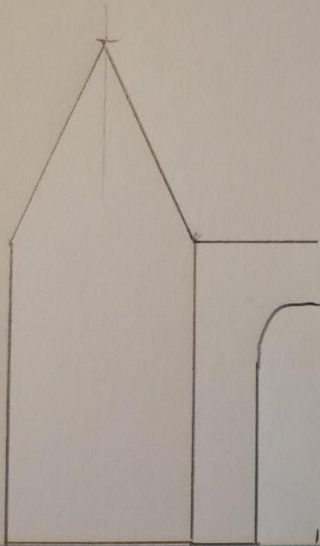



S. 150 Nr. 1

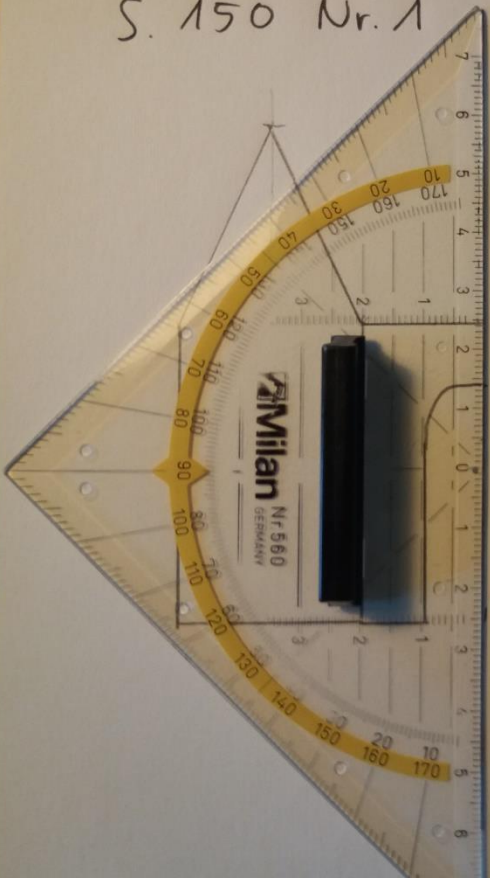

S. 150 Nr. 1

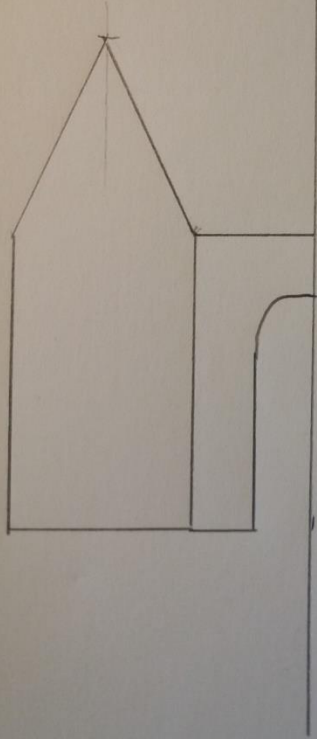

S. 150 Nr. 1

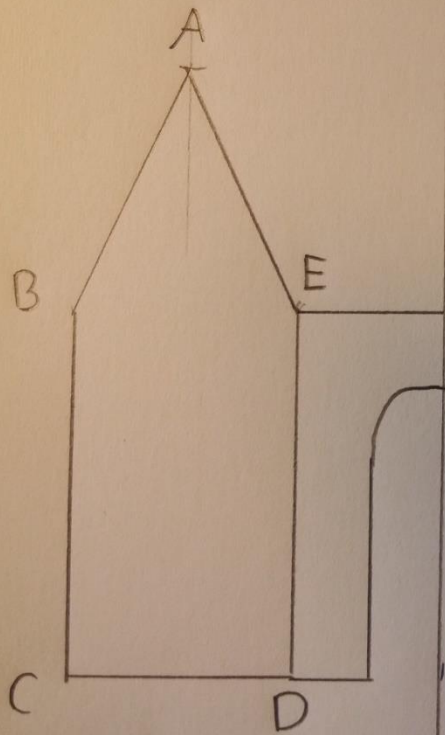

S. 150 Nr. 1

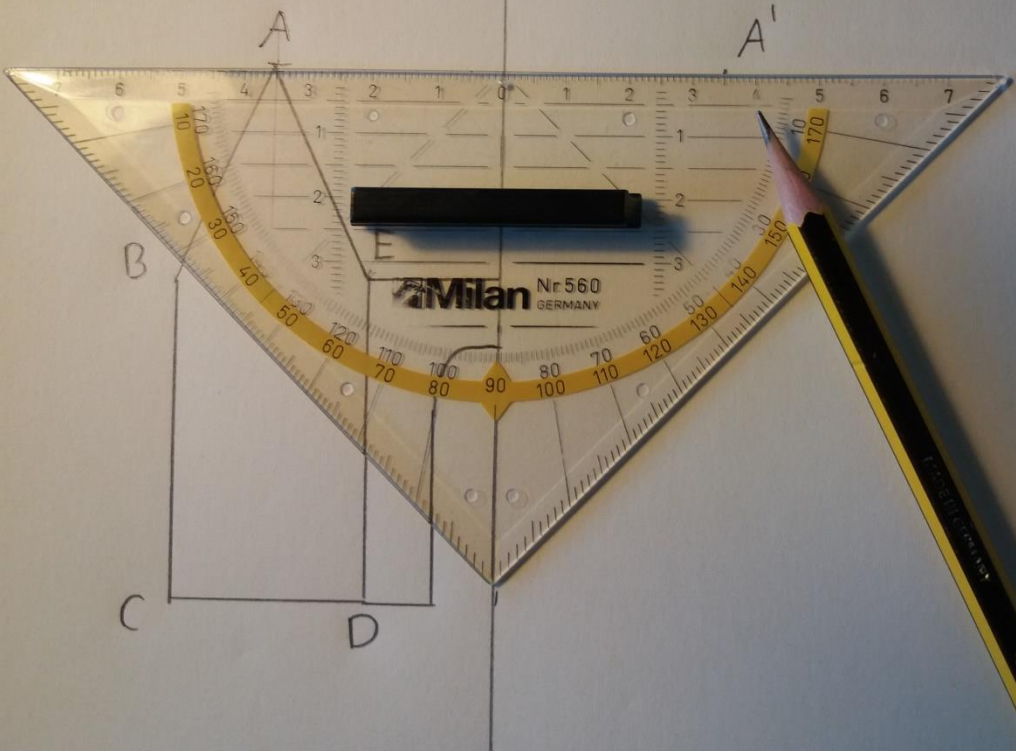

S. 150 Nr. 1

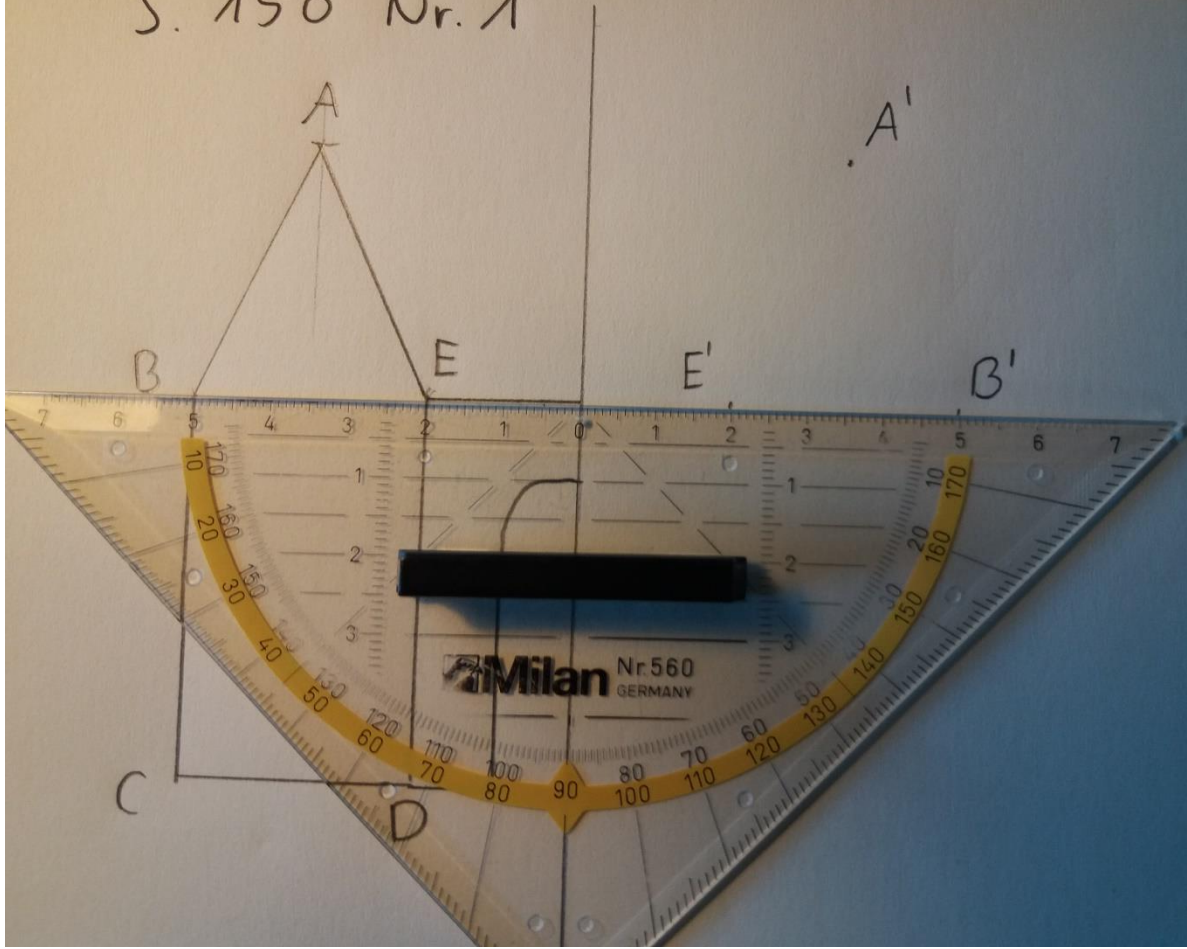

S. 150 Nr. 1

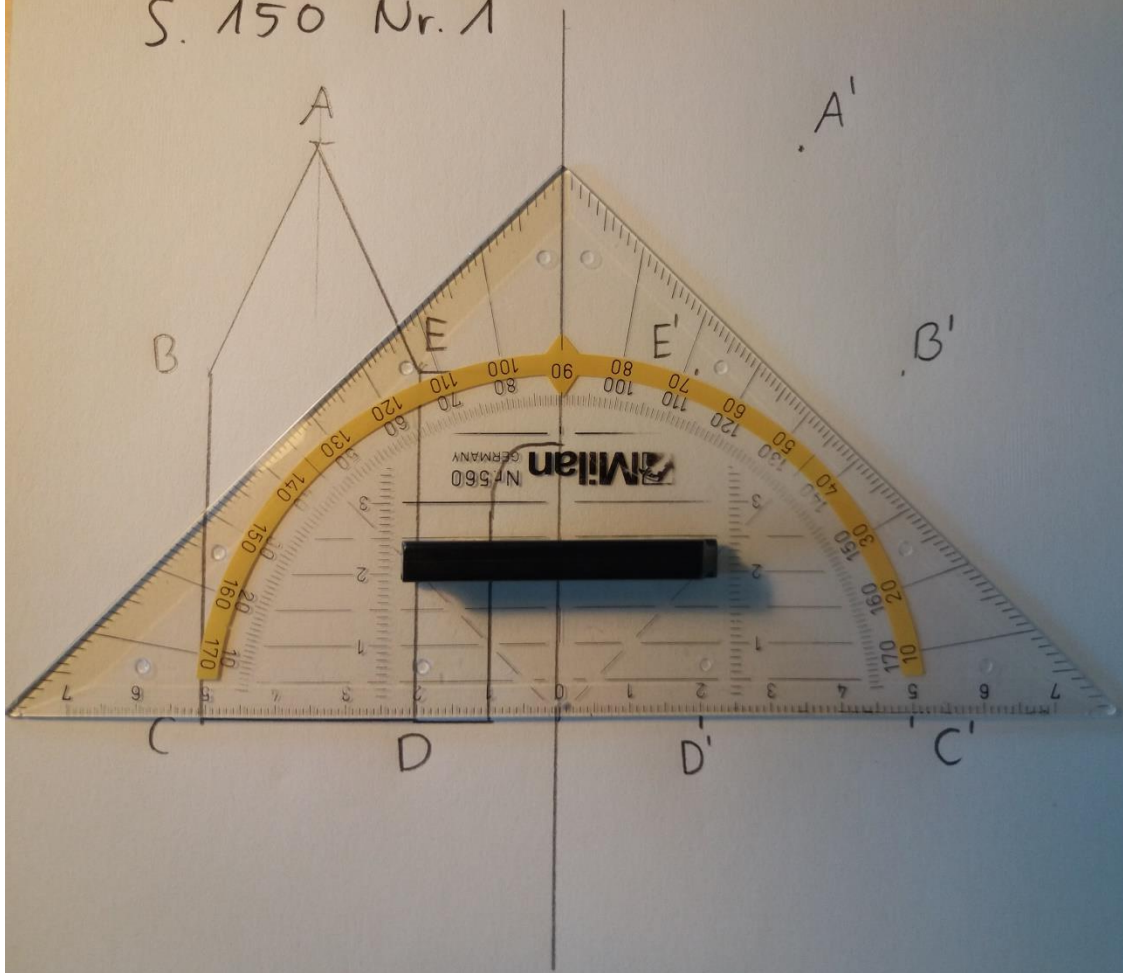

S. 150 Nr. 1

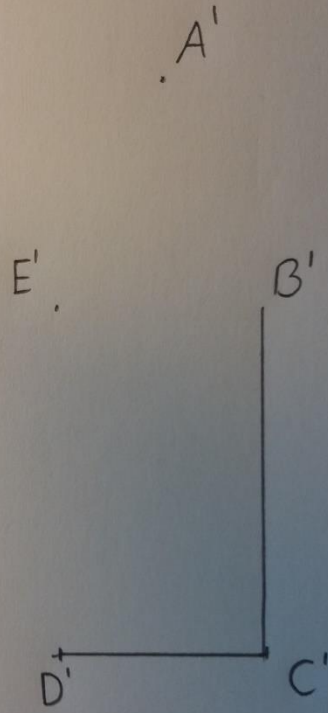
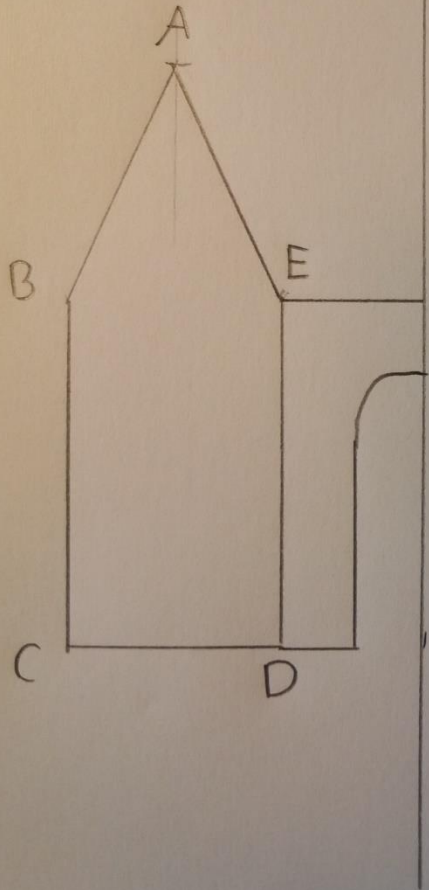

S. 150 Nr. 1

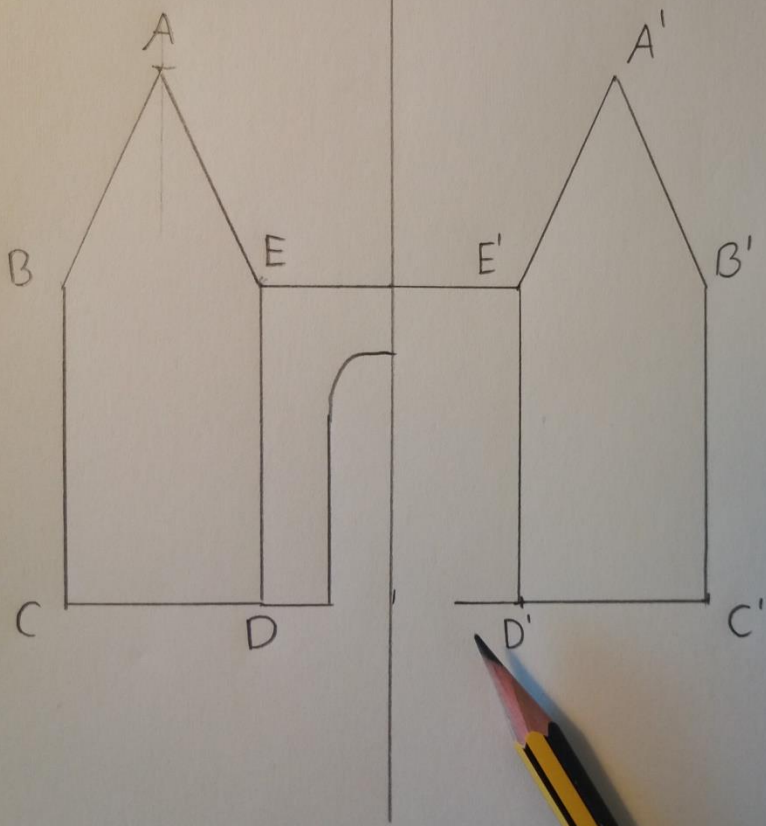



S. 150 Nr. 1

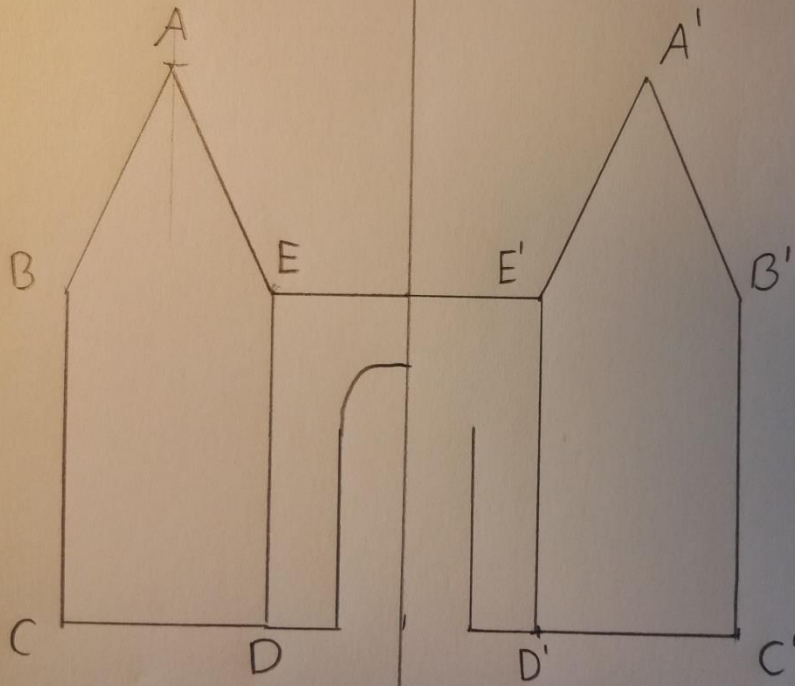

S. 150 Nr. 1

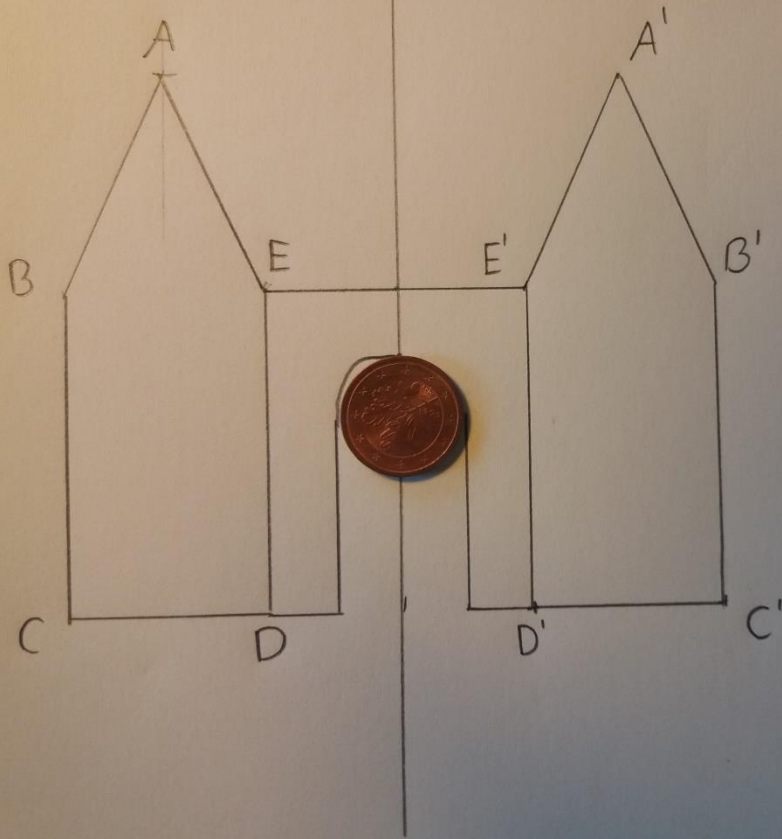

S. 150 Nr. 1

